

WARD 6 SIDEWALKS 60% SUBMITTAL

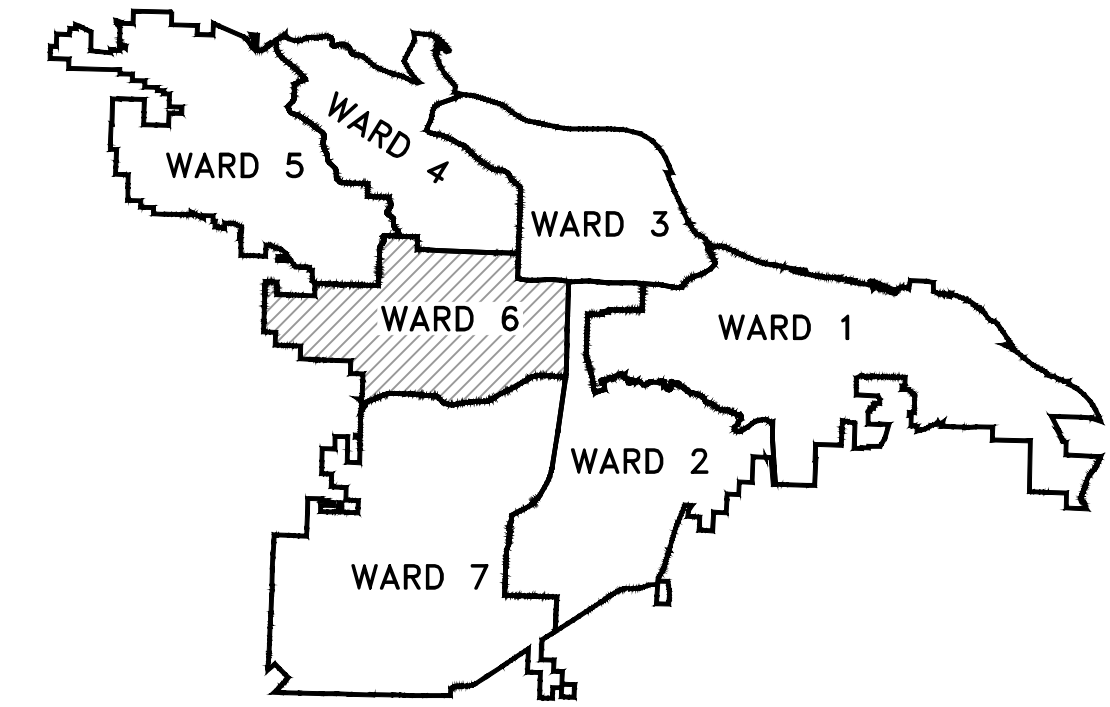

PROJECT LOCATION - WARD 1

SHEET NO.	TITLE
C1	COVER SHEET
C2	LEGEND AND QUANTITIES
C3	EXISTING CONDITIONS 1 - ALDERSGATE RD
C4	EXISTING CONDITIONS 2 - ALDERSGATE RD
C5	EXISTING CONDITIONS 1 - 28TH ST
C6	EXISTING CONDITIONS 2 - 28TH ST
C7	PLAN 1 - ALDERSGATE RD
C8	PLAN 2 - ALDERSGATE RD
C9	PLAN 1 - 28TH ST
C10	PLAN 2 - 28TH ST
C11	DRIVEWAY PROFILES - ALDERSGATE RD
C12	DRIVEWAY PROFILES 1 - 28TH ST
C13	DRIVEWAY PROFILES 2 - 28TH ST
C14	DRIVEWAY PROFILES 3 - 28TH ST

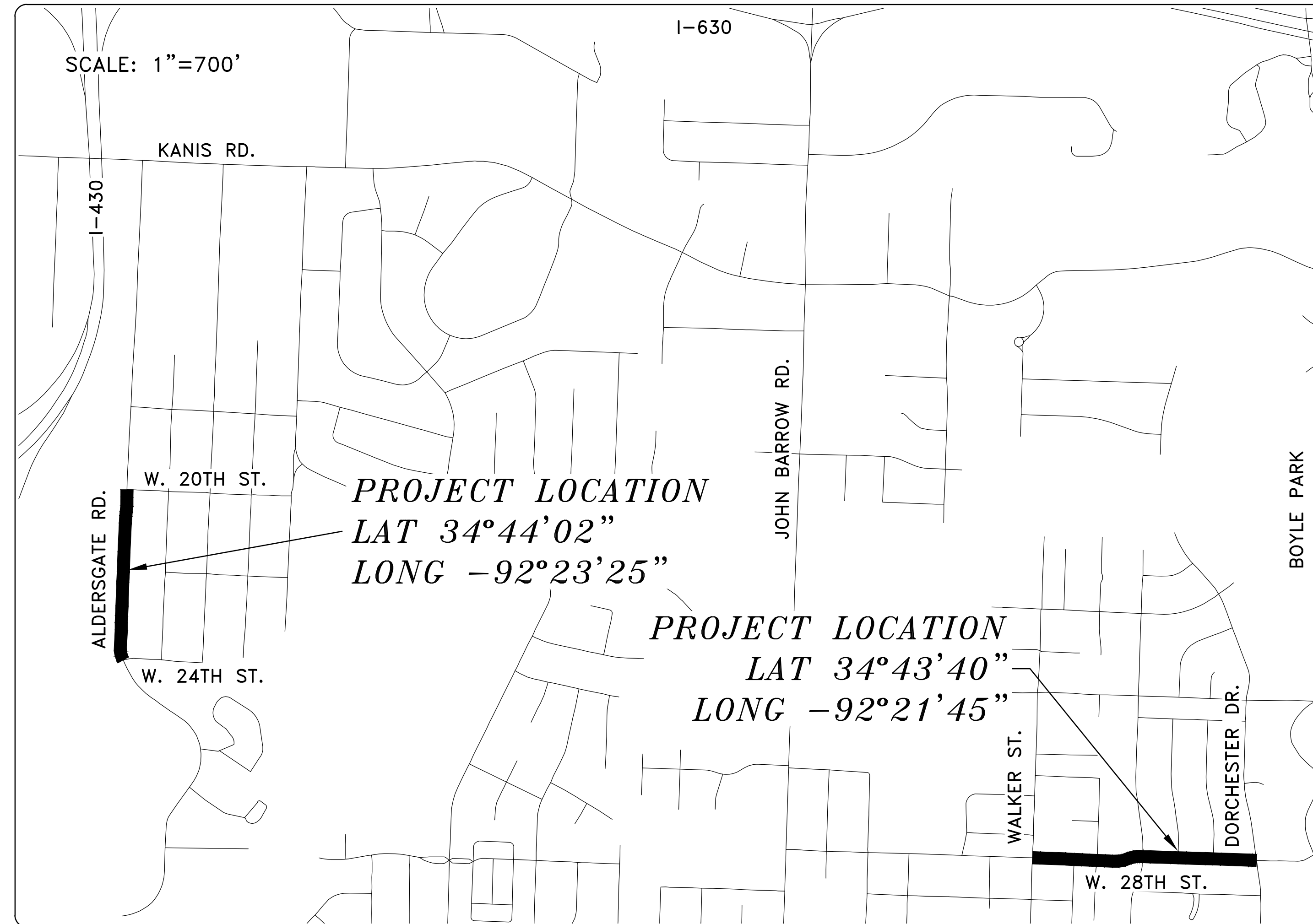
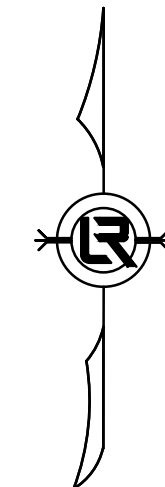
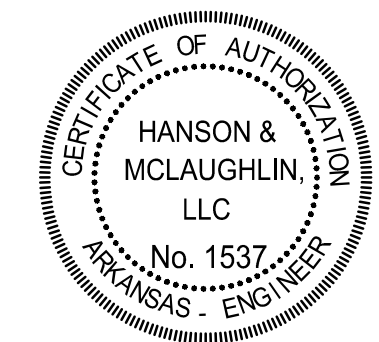

DEPARTMENT OF PUBLIC WORKS
CIVIL ENGINEERING
701 WEST MARKHAM STREET
LITTLE ROCK, ARKANSAS 72201

HANSON & MCLAUGHLIN, LLC
320 EXECUTIVE COURT, SUITE 202
LITTLE ROCK, ARKANSAS 72205
(501) 716-2850

REVISIONS	DATE

WARD 6 SIDEWALKS
CITY OF LITTLE ROCK, ARKANSAS
COVER SHEET

DEPARTMENT OF PUBLIC WORKS
CIVIL ENGINEERING
701 W. MARKHAM
LITTLE ROCK, ARKANSAS 72201



DRAWN BY KMH
DESIGNED KMH
CHECKED FJS
DATE 10-28-2024
SCALE N.T.S.
PROJECT NO. 06-XX-SW-XX
SHEET NO. C1

ITEM #	ITEM DESCRIPTION	UNIT	QUANTITY
2.01	Site Preparation (Incl. Mobilization)	LS	1
3.01	Unclassified Excavation	CY	20
3.06	Borrow Material	CY	20
7.06	Concrete Driveway (6" Thick), Standard Finish	SF	4,327
9.04	Concrete Sidewalk (4" Thick)	SF	7,707
9.40	Concrete Sidewalk "Turn Up" Wall	SF	20
14.01	Solid Sodding (Bermuda) Includes 4" Topsoil	SY	1,199
16.01	Maintenance of Traffic	LS	1
17.01	Pavement Repairs	SY	20
18.10	Manhole Ring and Cover Adjusted to Grade	EA	1
18.50	Access Ramp	SF	727
18.55	Water for Dust Control	GAL	1,000
19.01	Final Clean-Up	LS	1

ITEM #	ITEM DESCRIPTION	UNIT	QUANTITY
2.01	Site Preparation (Incl. Mobilization)	LS	1
2.02	Clearing and Grubbing Trees	LS	1
3.01	Unclassified Excavation	CY	40
3.06	Borrow Material	CY	40
7.18	Concrete Driveway (8" Thick), Standard Finish	SF	414
9.04	Concrete Sidewalk (4" Thick)	SF	8,188
9.04 SP	Sidewalk Over Exposed Tree Roots	SF	20
13.18C	Storm Drain Pipes, 18", Side Drain	LF	20
14.01	Solid Sodding (Bermuda) Includes 4" Topsoil	SY	1,092
16.01	Maintenance of Traffic	LS	1
17.01	Pavement Repairs	SY	15
18.50	Access Ramp	SF	70
18.55	Water for Dust Control	GAL	1,000
19.01	Final Clean-Up	LS	1
24.09	Sediment Barrier, Block (SD4)	EA	2
24.11	Silt Fence - Type A (SFA)	LF	50

EXISTING

- IRON ROD
- PK NAIL
- R.R. SPIKE
- CONC. MONUMENT
- WATER VALVE
- WATER METER
- FIRE HYDRANT
- GAS METER
- GAS VALVE
- CLEAN-OUT
- GUARD POST (BOLLARD)
- SIGN POST
- BENCHMARK
- STORM SEWER MANHOLE
- SANITARY SEWER MANHOLE
- TELEPHONE MANHOLE
- ELECTRIC MANHOLE
- TELEPHONE BOX
- ELECTRIC BOX
- CABLE BOX
- UTILITY POLE
- GUY WIRE
- LIGHT POLE
- POST OR POLE (TYPE AS NOTED)
- MAILBOX
- DECIDUOUS TREE
- EVERGREEN/CONIFEROUS TREE
- BUSH
- PROPERTY LINE
- SETBACK LINE
- EASEMENT LINE
- CURB
- FENCE
- OVERHEAD UTILITY
- UNDERGROUND TELEPHONE
- UNDERGROUND ELECTRIC
- WATER LINE
- SEWER LINE
- GAS LINE
- STORM SEWER/CULVERT
- CONTOUR LINE

PROPOSED

- CONTOUR
- SPOT ELEVATION
- SPOT CURB ELEVATION
- STORM SEWER - PIPE
- STORM SEWER - MITERED END SECTION
- STORM SEWER - GRATE INLET
- STORM SEWER - JUNCTION BOX
- STORM SEWER - FLARED END SECTION
- STORM SEWER - HEADWALL
- STORM SEWER - INLET WITH SINGLE EXTENSION
- STORM SEWER - INLET WITH DOUBLE EXTENSION
- STORM SEWER - AREA INLET
- GRADE BREAK LINE
- HIGH POINT
- LOW POINT
- CUT LINE
- FILL LINE
- SANITARY SEWER PIPE
- SANITARY SEWER MANHOLE
- CURB
- CONCRETE
- CONSTRUCTION - ENTRANCE/EXIT
- CHECK DAM
- DIVERSION BERM
- DOWNDRAIN STRUCTURE - TEMPORARY
- ROCK DAM
- SEDIMENT BARRIER - SILT FENCE
- SEDIMENT BARRIER - GRAVEL RING
- SEDIMENT BARRIER - BLOCK & GRAVEL
- SEDIMENT BARRIER - BLOCK
- TEMPORARY SEDIMENT BASIN
- SILT FENCE - TYPE A
- SILT FENCE - TYPE B
- SILT FENCE - TYPE C
- STORM DRAIN OUTLET PROTECTION
- SURFACE ROUGHENING
- DISTURBED AREA STABILIZATION - TEMPORARY STABILIZATION
- DISTURBED AREA STABILIZATION - TEMPORARY GRASSING
- DISTURBED AREA STABILIZATION - PERMANENT GRASSING
- MATTING/BLANKETS

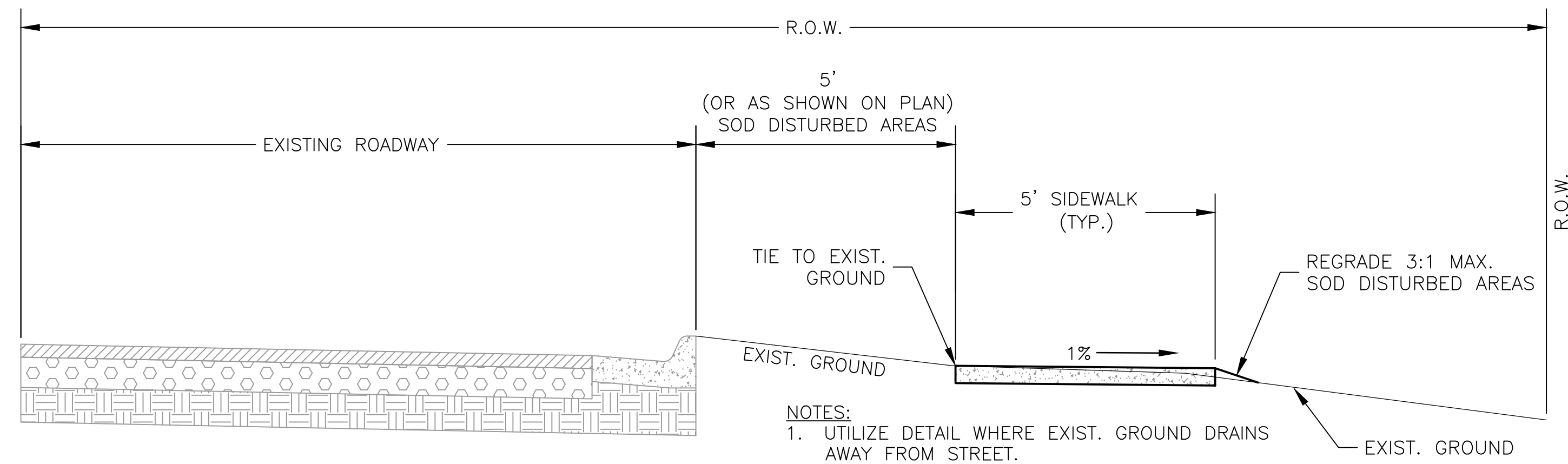
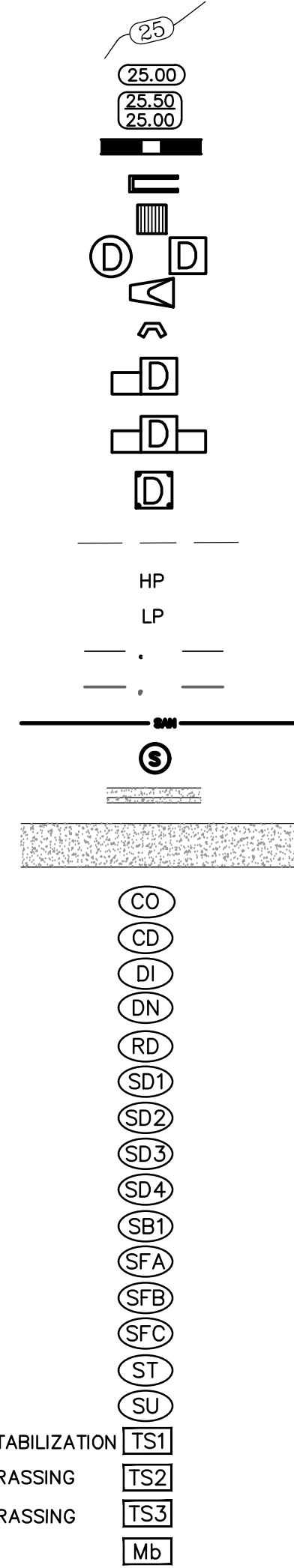

SIDEWALK DRAINING AWAY FROM STREET
NTS

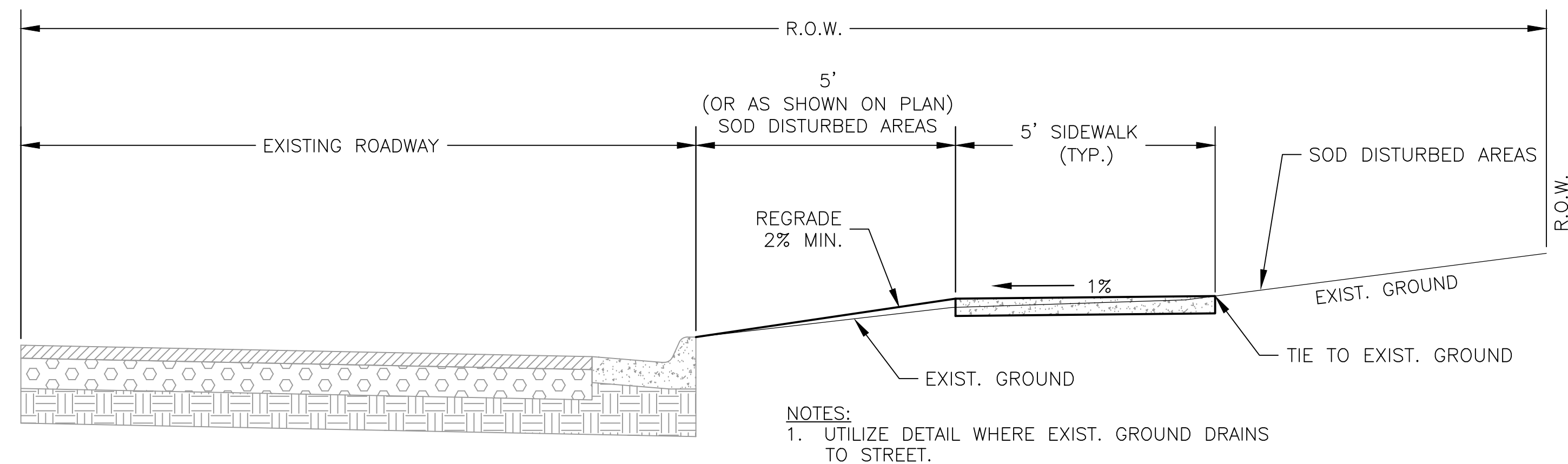

SIDEWALK DRAINING TO STREET
NTS

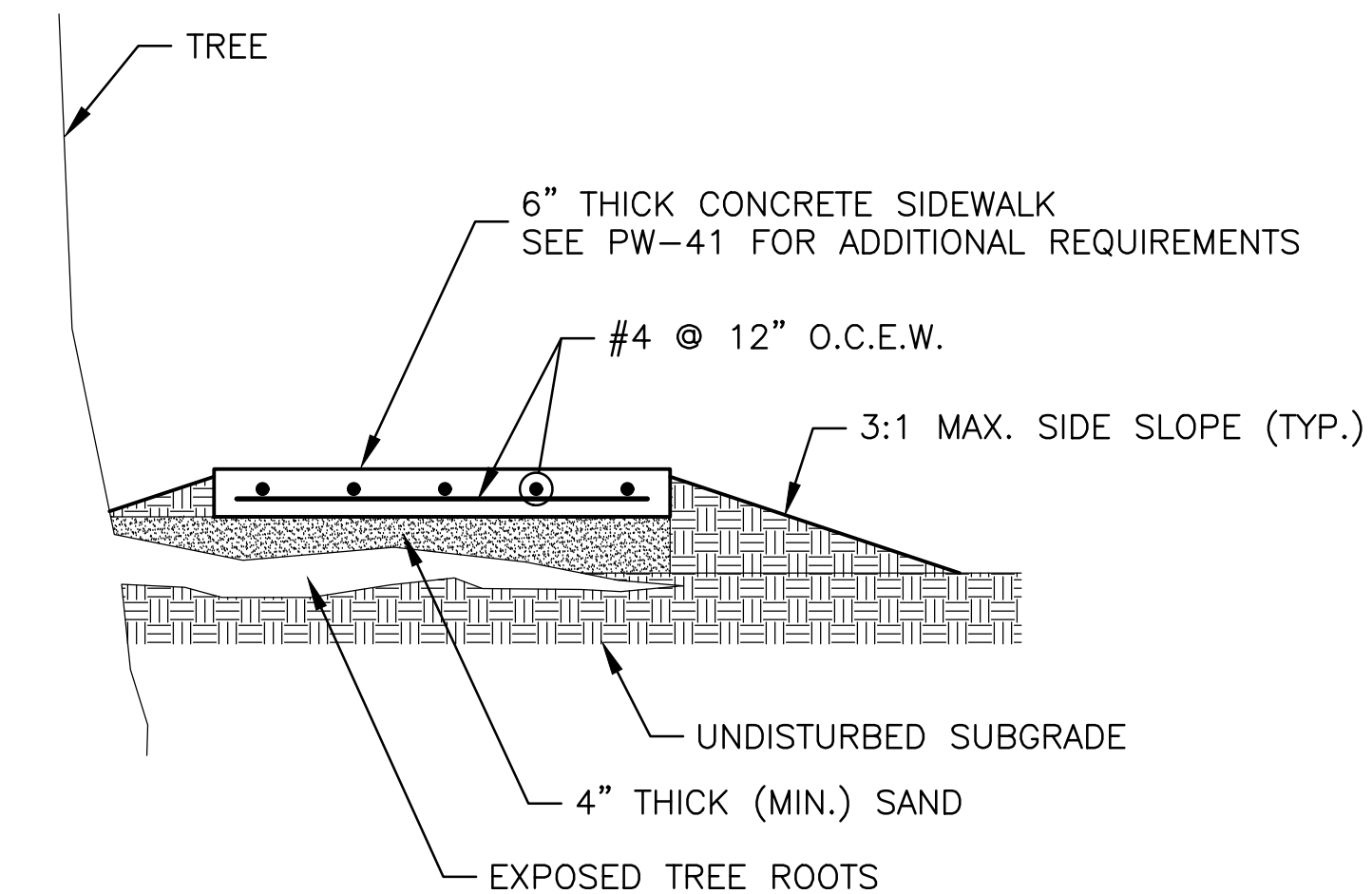

SP-SIDEWALK OVER EXPOSED TREE ROOTS
NTS

REVISIONS	DATE

WARD 6 SIDEWALKS
CITY OF LITTLE ROCK, ARKANSAS
LEGEND AND QUANTITIES

DEPARTMENT OF PUBLIC WORKS
CIVIL ENGINEERING
701 W. MARKHAM
LITTLE ROCK, ARKANSAS 72201



DRAWN BY	KMH
DESIGNED	KMH
CHECKED	FJS
DATE	10-28-2024
SCALE	N.T.S.
PROJECT NO.	06-XX-SW-XX
SHEET NO.	C2

REVISIONS	DATE

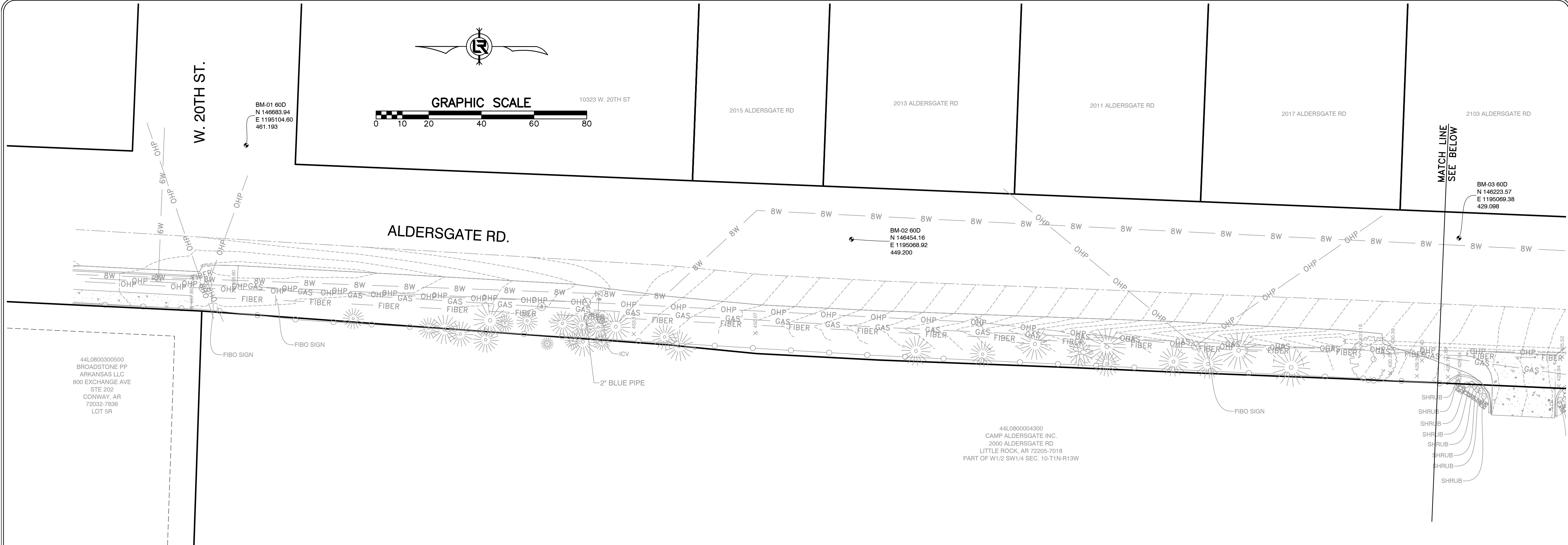

WARD 6 SIDEWALKS
CITY OF LITTLE ROCK, ARKANSAS
EXISTING CONDITIONS 1 - ALDERSGATE ROAD

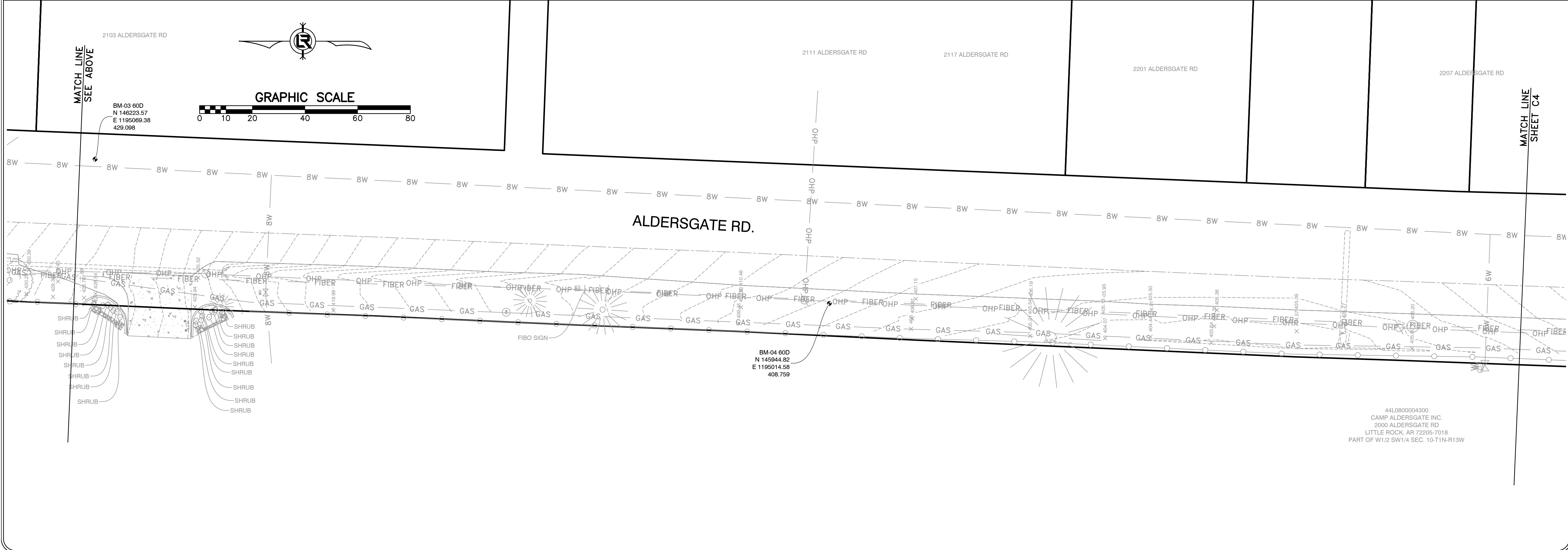

DEPARTMENT OF PUBLIC WORKS
 CIVIL ENGINEERING
 701 W. MARKHAM
 LITTLE ROCK, ARKANSAS 72201



DRAWN BY
KMH
DESIGNED
KMH
CHECKED
FJS
DATE
10-28-2024
SCALE
1"=20'
PROJECT NO.
06-xx-SW-XX
SHEET NO.
C3

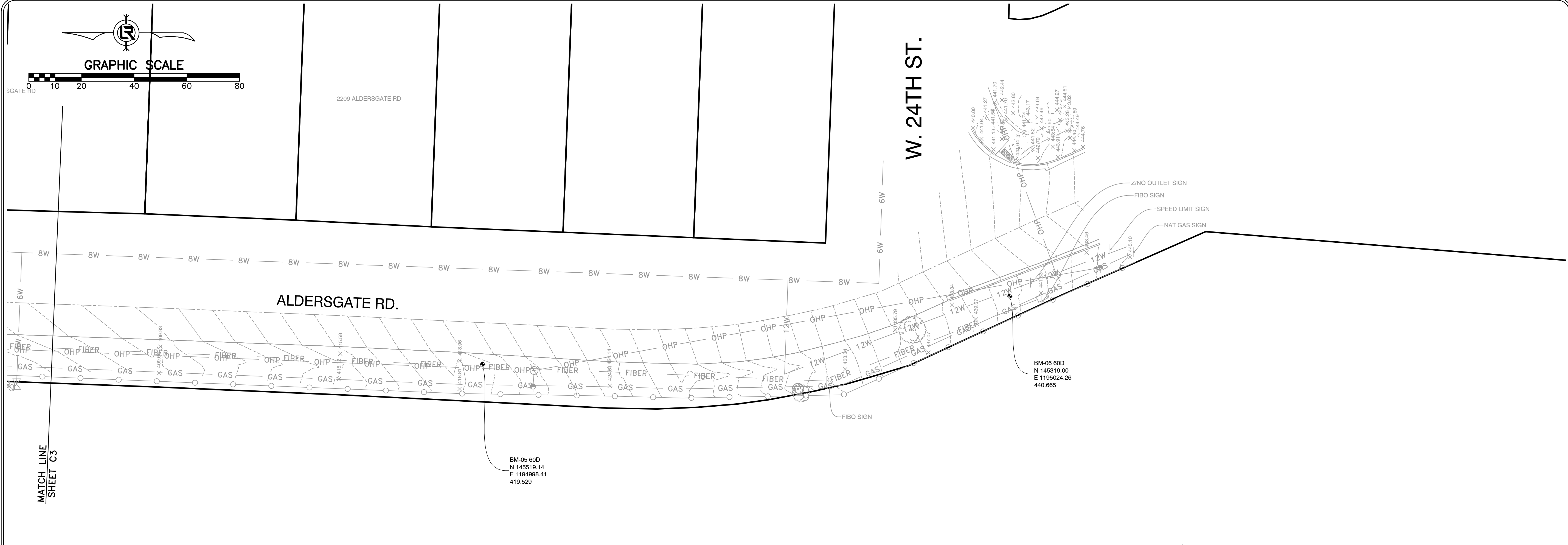

REVISIONS	DATE

WARD 6 SIDEWALKS
CITY OF LITTLE ROCK, ARKANSAS
EXISTING CONDITIONS 2 - ALDERSGATE ROAD

DEPARTMENT OF PUBLIC WORKS
 CIVIL ENGINEERING
 701 W. MARKHAM
 LITTLE ROCK, ARKANSAS 72201



DRAWN BY KMH
DESIGNED KMH
CHECKED FJS
DATE 10-28-2024
SCALE 1"=20'
PROJECT NO. 06-xx-SW-XX
SHEET NO. C4

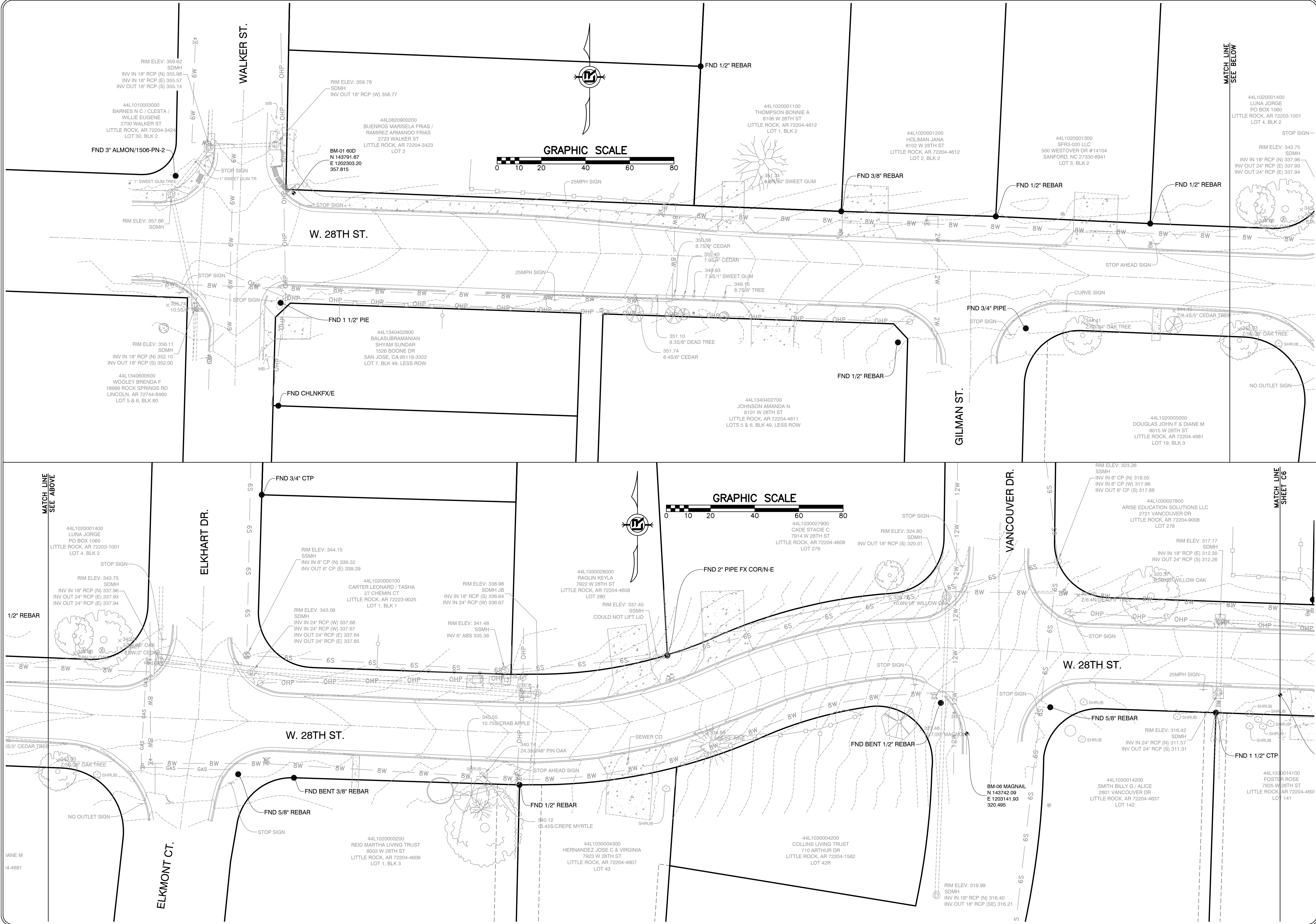

REVISIONS	DATE

WARD 6 SIDEWALKS
CITY OF LITTLE ROCK, ARKANSAS
EXISTING CONDITIONS 1 - 28TH STREET

DEPARTMENT OF PUBLIC WORKS
CIVIL ENGINEERING
 701 W. MARKHAM
 LITTLE ROCK, ARKANSAS 72201



DRAWN BY
KMH
DESIGNED
KMH
CHECKED
FJS
DATE
10-28-2024
SCALE
1"=20'
PROJECT NO.
06-xx-SW-XX
SHEET NO.
C5

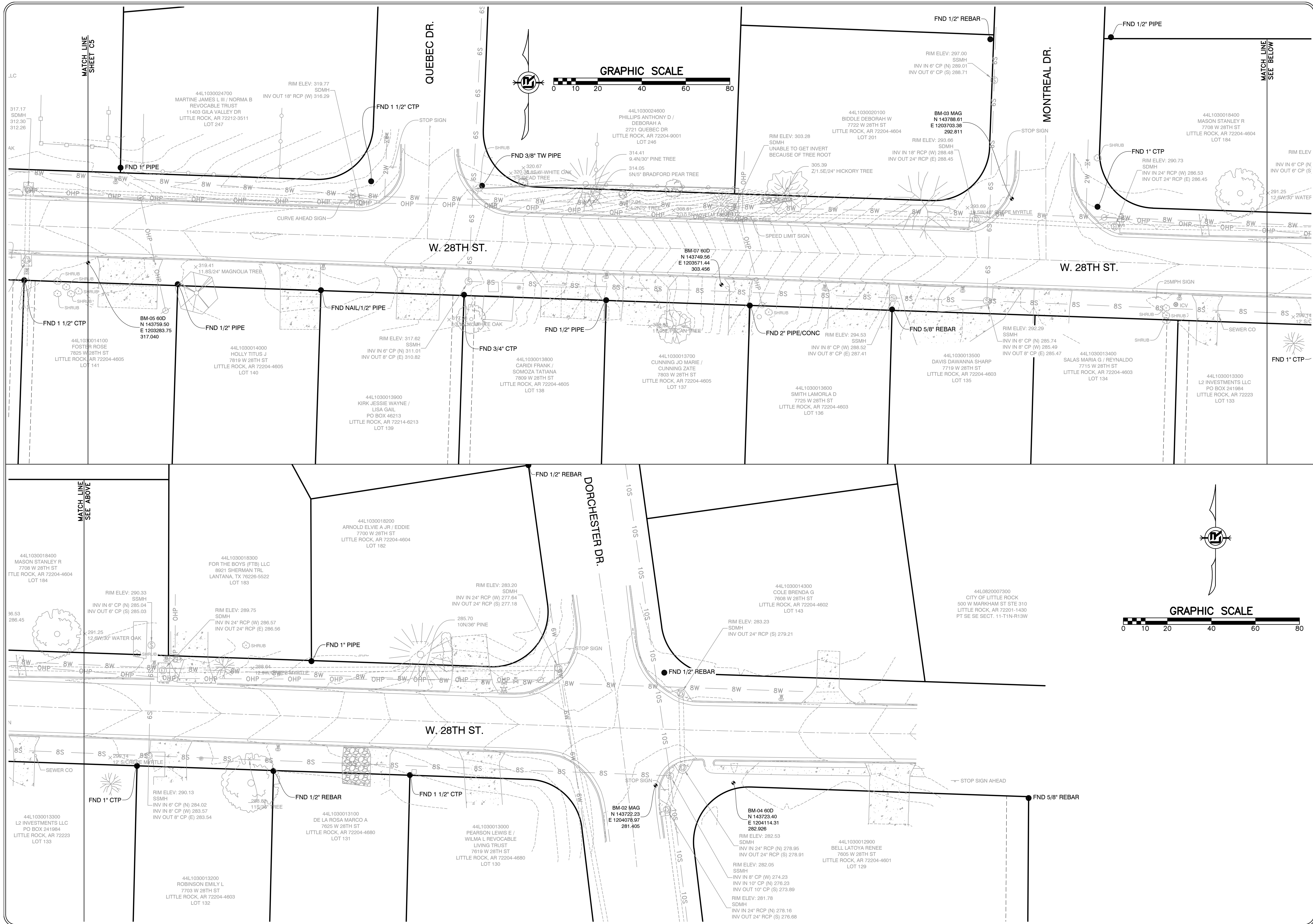

REVISIONS	DATE

WARD 6 SIDEWALKS
CITY OF LITTLE ROCK, ARKANSAS
EXISTING CONDITIONS 2 - 28TH STREET

DEPARTMENT OF PUBLIC WORKS
 CIVIL ENGINEERING
 701 W. MARKHAM
 LITTLE ROCK, ARKANSAS 72201



DRAWN BY
 KMH
DESIGNED
 KMH
CHECKED
 FJS
DATE
 10-28-2024
SCALE
 1"=20'
PROJECT NO.
 06-xx-SW-XX
SHEET NO.
 C6

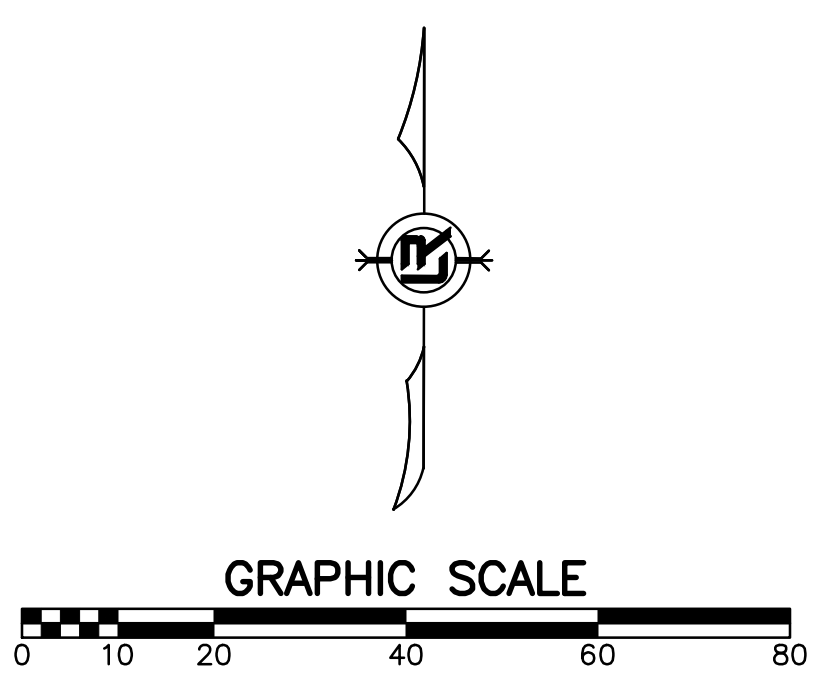
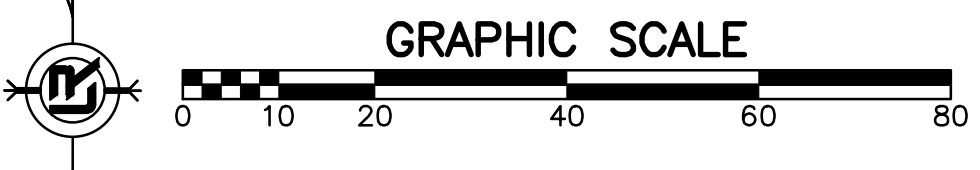

REVISIONS	DATE

WARD 6 SIDEWALKS
CITY OF LITTLE ROCK, ARKANSAS
PLAN 1 - ALDERSGATE ROAD

DEPARTMENT OF PUBLIC WORKS
 CIVIL ENGINEERING
 701 W. MARKHAM
 LITTLE ROCK, ARKANSAS 72201



DRAWN BY
KMH
DESIGNED
KMH
CHECKED
FJS
DATE
10-28-2024
SCALE
1"=20'
PROJECT NO.
06-xx-SW-XX
SHEET NO.
C7

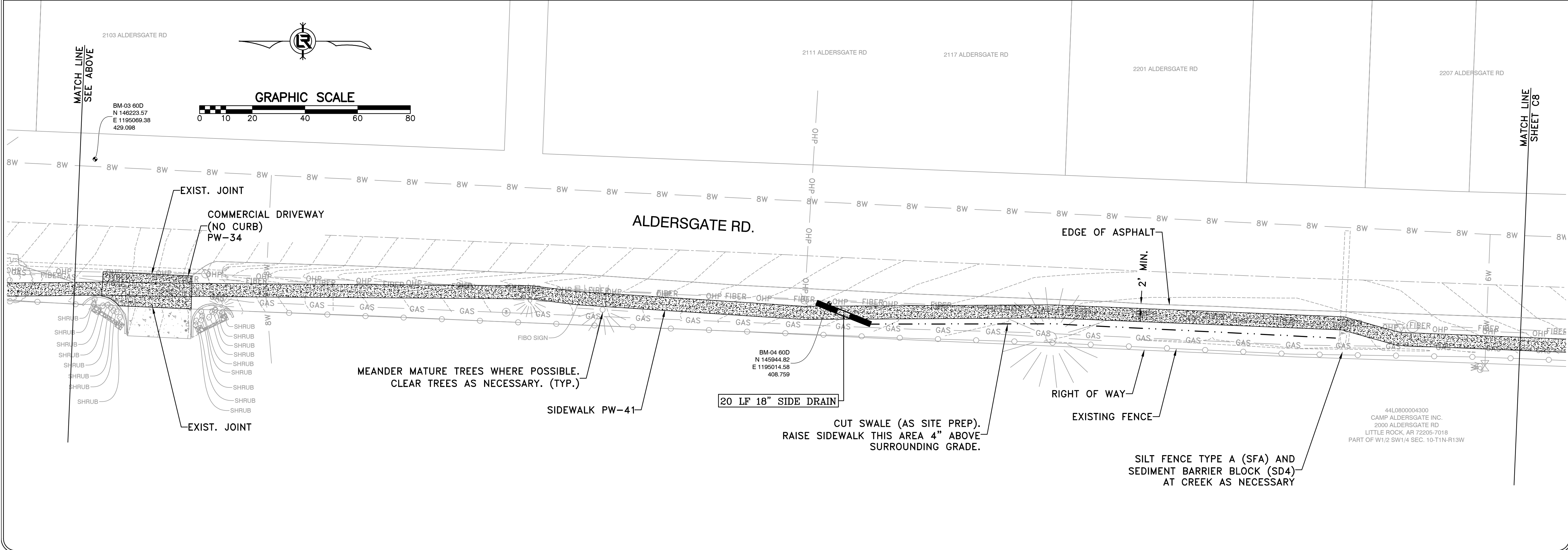
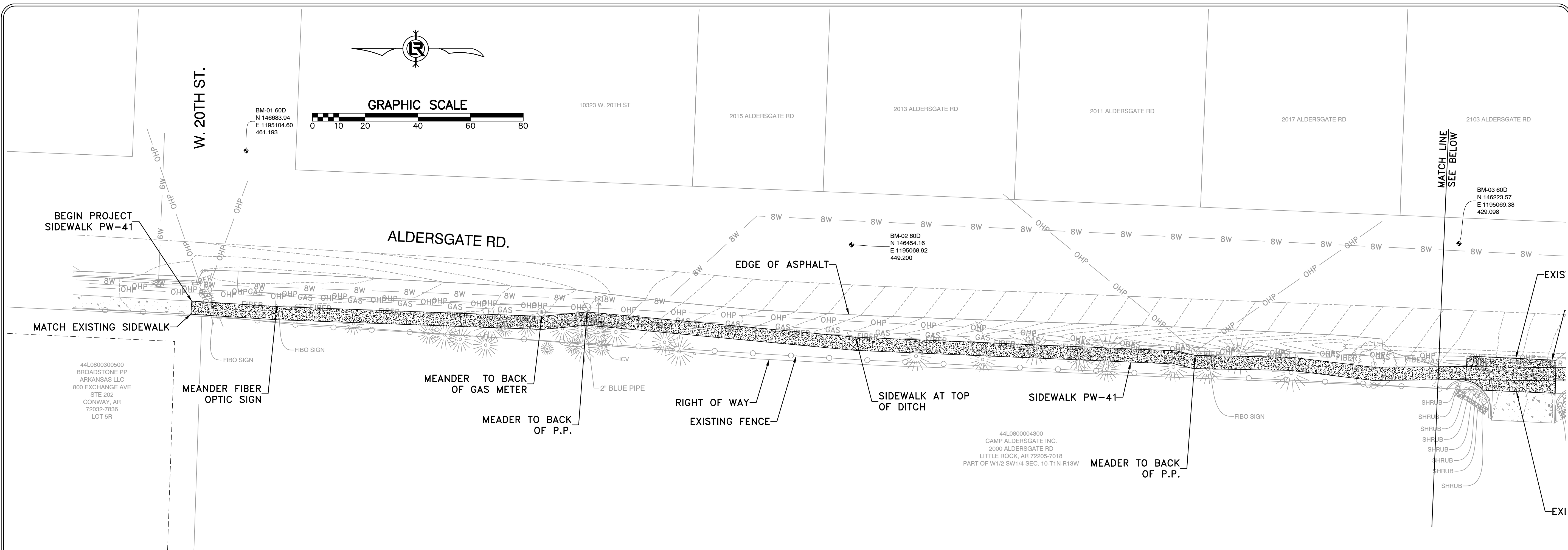

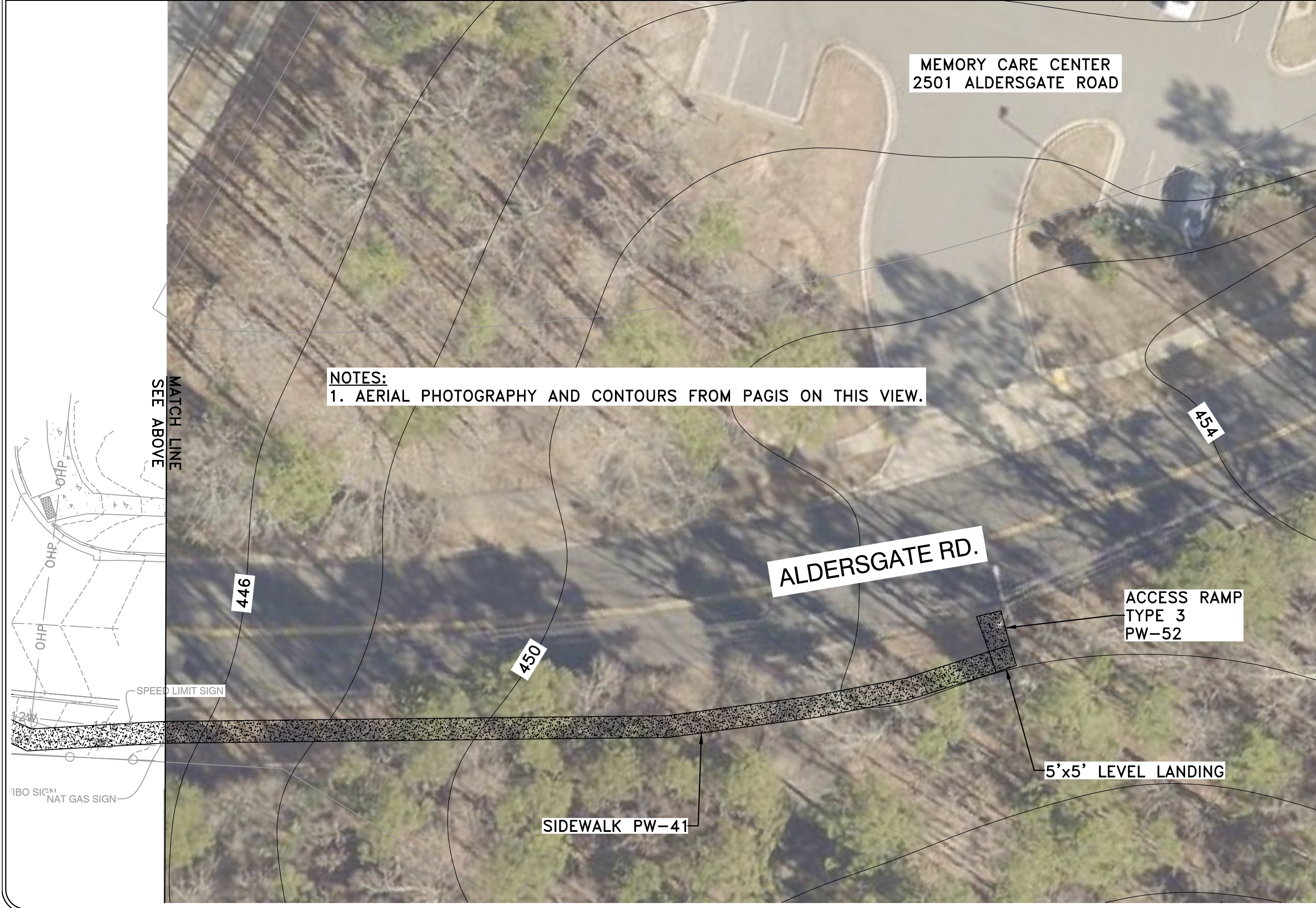
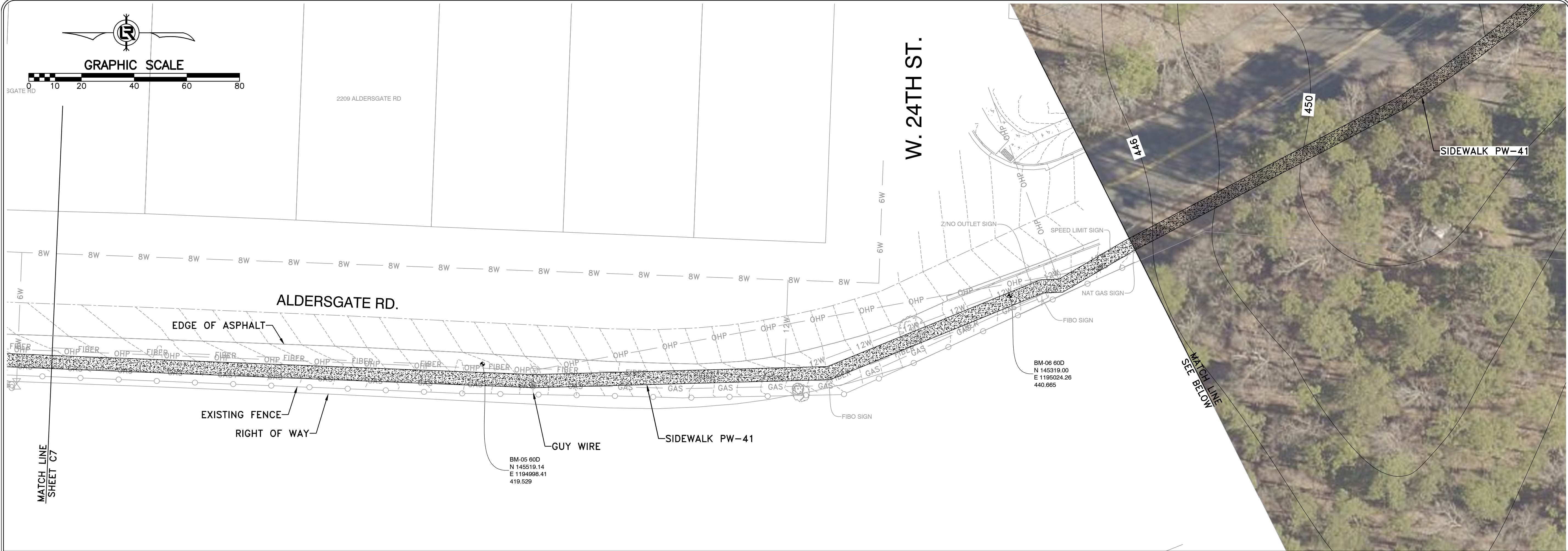

REVISIONS	DATE

WARD 6 SIDEWALKS
CITY OF LITTLE ROCK, ARKANSAS
PLAN 2 - ALDERSGATE ROAD

DEPARTMENT OF PUBLIC WORKS
CIVIL ENGINEERING
701 W. MARKHAM
LITTLE ROCK, ARKANSAS 72201



DRAWN BY
KMH
DESIGNED
KMH
CHECKED
FJS
DATE
10-28-2024
SCALE
1"=20'
PROJECT NO.
06-xx-SW-XX
SHEET NO.
C8

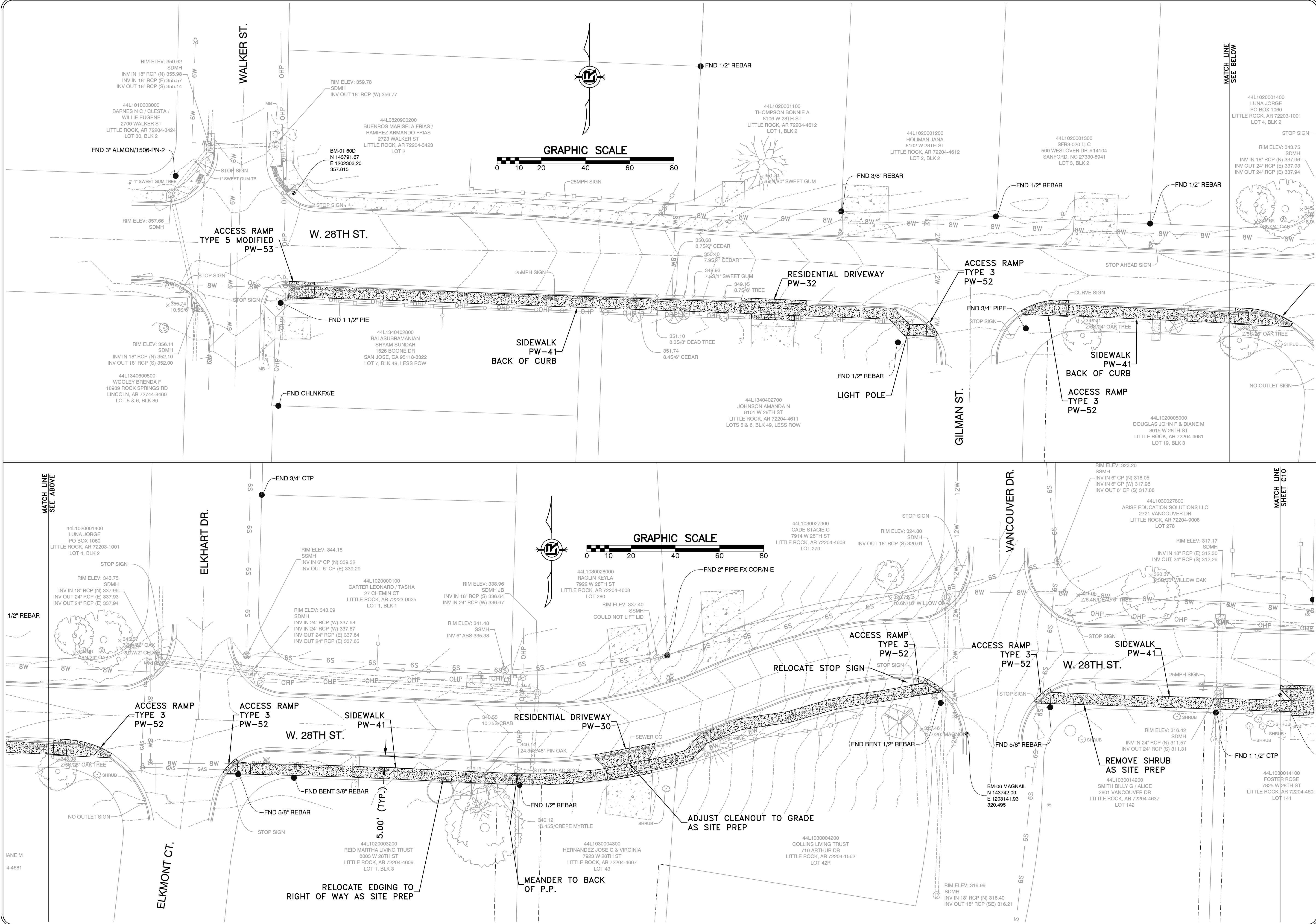

REVISIONS	DATE

WARD 6 SIDEWALKS
CITY OF LITTLE ROCK, ARKANSAS
PLAN 1 - 28TH STREET

DEPARTMENT OF PUBLIC WORKS
 CIVIL ENGINEERING
 701 W. MARKHAM
 LITTLE ROCK, ARKANSAS 72201



DRAWN BY
KMH

DESIGNED
KMH

CHECKED
FJS

DATE
10-28-2024

SCALE
1"=20'

PROJECT NO.
06-xx-SW-XX

SHEET NO.
C9

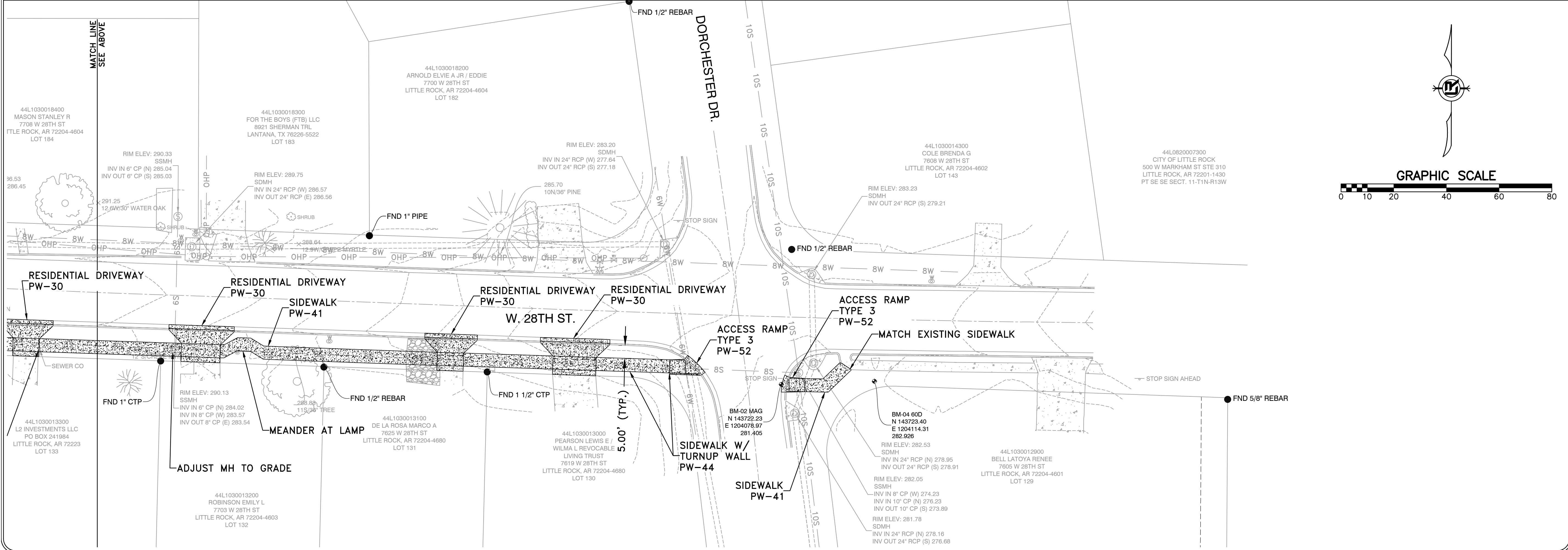
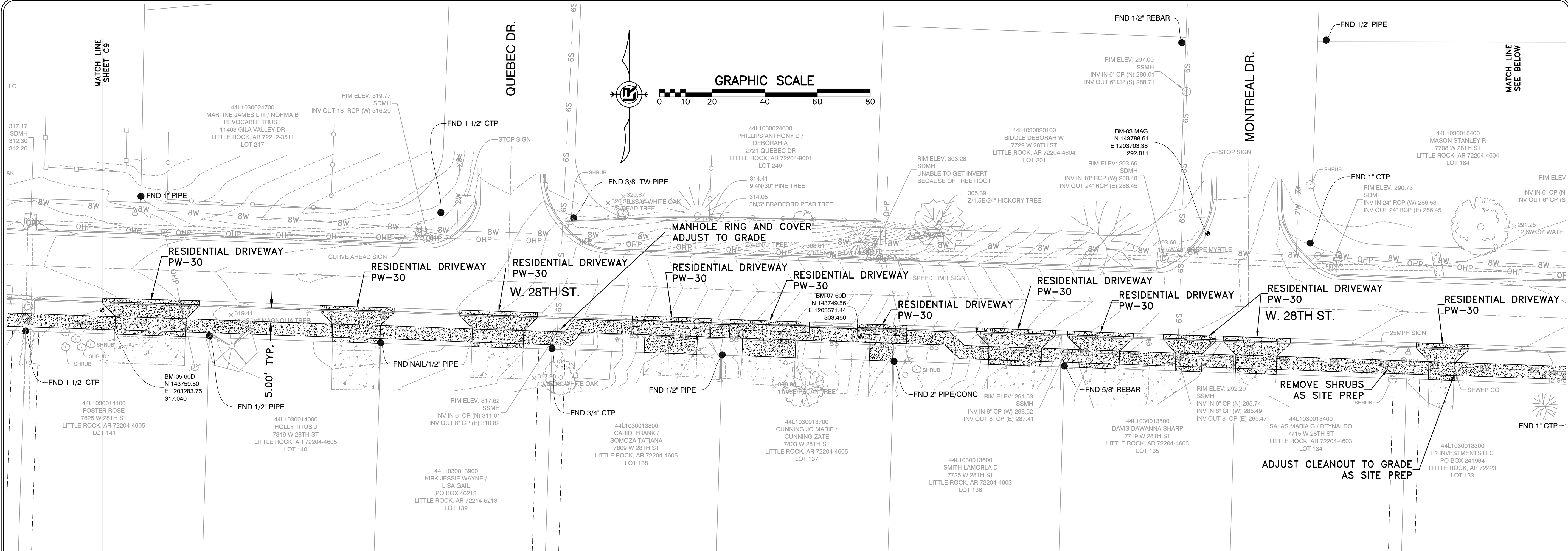

REVISIONS	DATE

WARD 6 SIDEWALKS
CITY OF LITTLE ROCK, ARKANSAS
PLAN 2 - 28TH STREET

DEPARTMENT OF PUBLIC WORKS
 CIVIL ENGINEERING
 701 W. MARKHAM
 LITTLE ROCK, ARKANSAS 72201



DRAWN BY
KMH
 DESIGNED
KMH
 CHECKED
FJS
 DATE
10-28-2024
 SCALE
1"=20'
 PROJECT NO.
06-xx-SW-XX
 SHEET NO.
C10

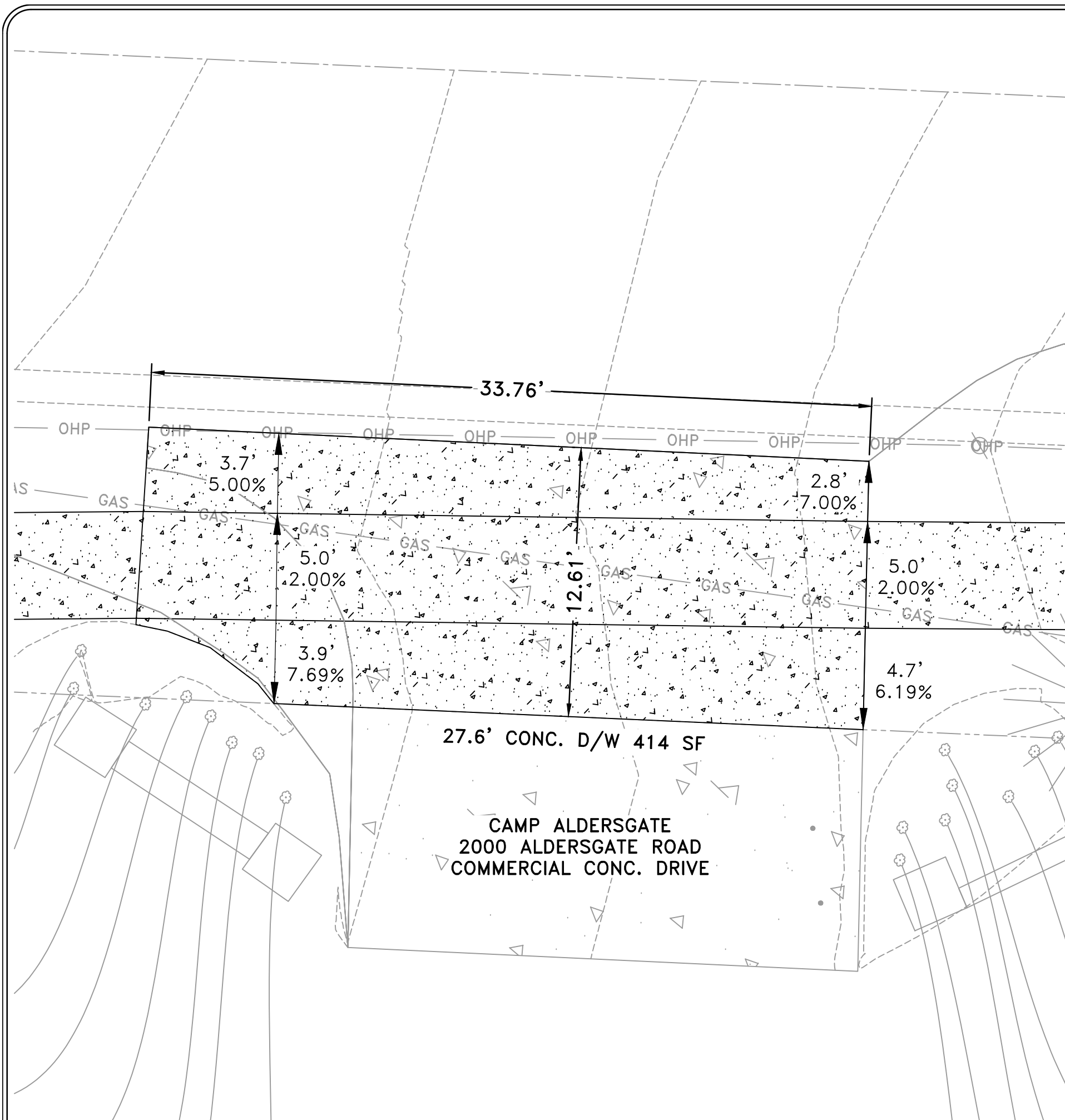

REVISIONS	DATE

WARD 6 SIDEWALKS
CITY OF LITTLE ROCK, ARKANSAS
DRIVEWAY PROFILES - ALDERSGATE ROAD

DEPARTMENT OF PUBLIC WORKS
CIVIL ENGINEERING
701 W. MARKHAM
LITTLE ROCK, ARKANSAS 72201



DRAWN BY
KMH
DESIGNED
KMH
CHECKED
FJS
DATE
10-28-2024
SCALE
1"=20'
PROJECT NO.
06-xx-SW-XX
SHEET NO.
C11

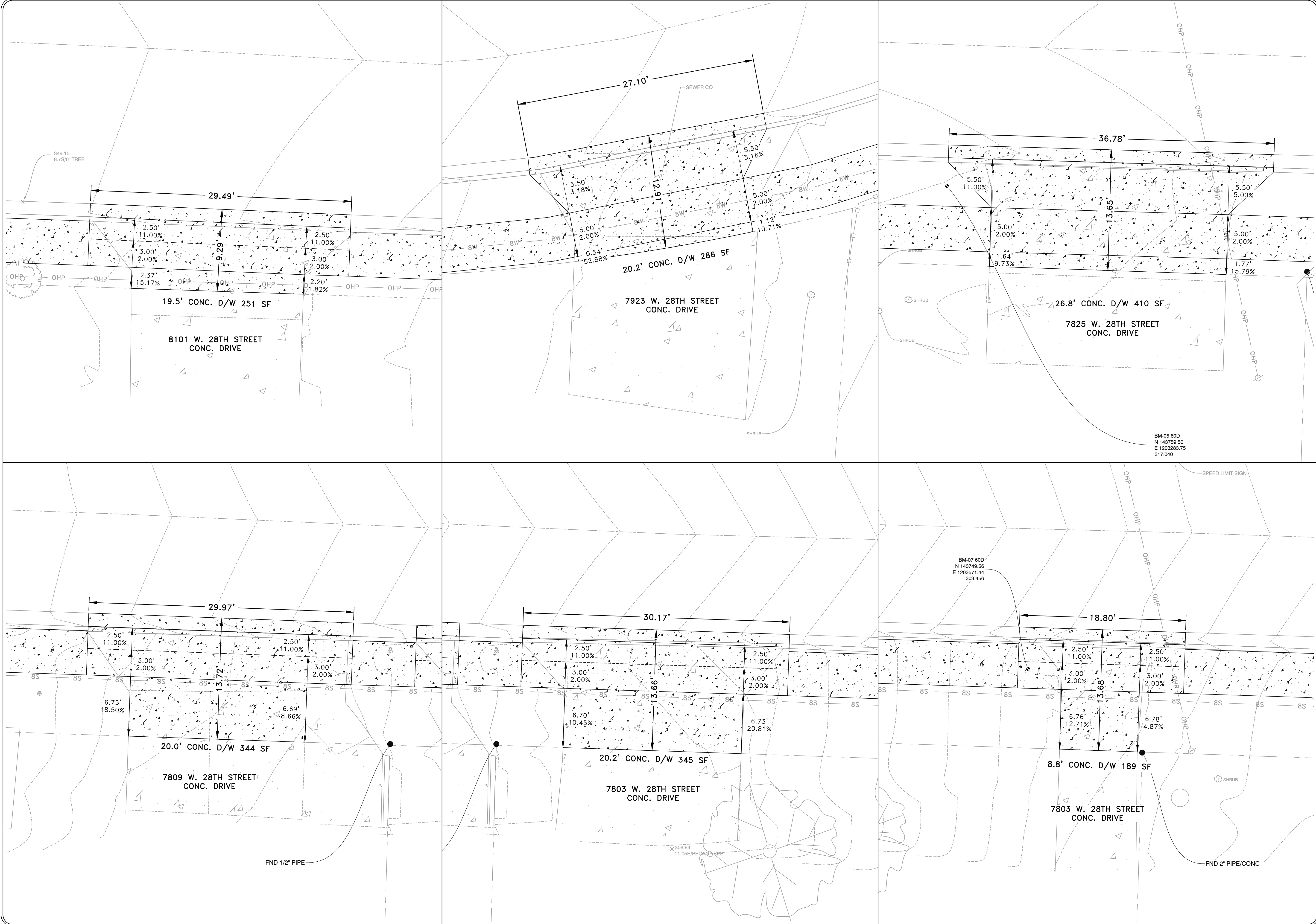

REVISIONS	DATE

WARD 6 SIDEWALKS
CITY OF LITTLE ROCK, ARKANSAS
DRIVEWAY PROFILES 1 - 28TH ST

DEPARTMENT OF PUBLIC WORKS
 CIVIL ENGINEERING
 701 W. MARKHAM
 LITTLE ROCK, ARKANSAS 72201



DRAWN BY
KMH
 DESIGNED
KMH
 CHECKED
FJS
 DATE
10-28-2024
 SCALE
1"=20'
 PROJECT NO.
06-xx-SW-XX
 SHEET NO.
C12

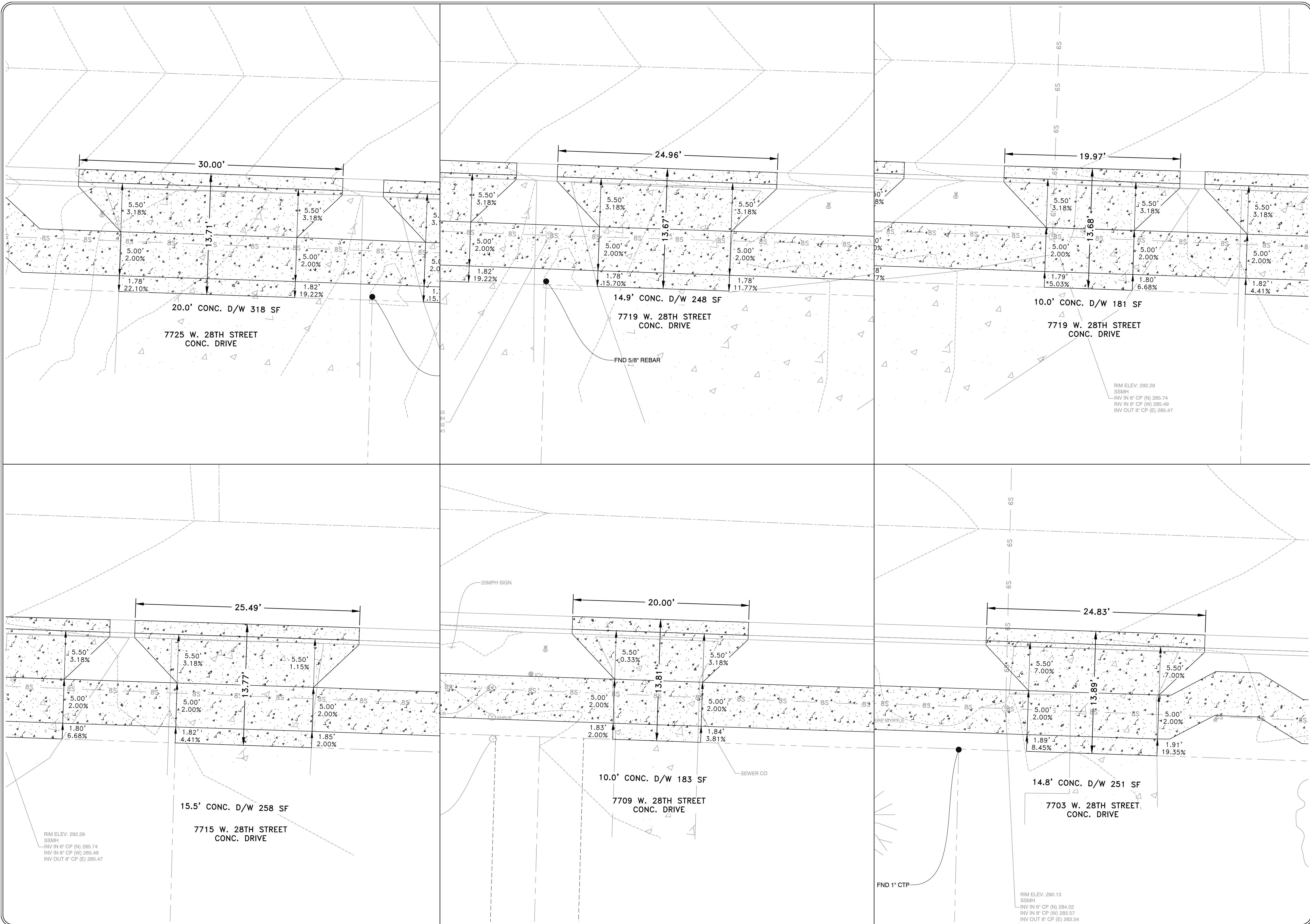

REVISIONS	DATE

WARD 6 SIDEWALKS
CITY OF LITTLE ROCK, ARKANSAS
 DRIVEWAY PROFILES 2 - 28TH ST

DEPARTMENT OF PUBLIC WORKS
 CIVIL ENGINEERING
 701 W. MARKHAM
 LITTLE ROCK, ARKANSAS 72201



DRAWN BY
KMH

DESIGNED
KMH

CHECKED
FJS

DATE
10-28-2024

SCALE
1"=20'

PROJECT NO.
06-xx-SW-XX

SHEET NO.
C13

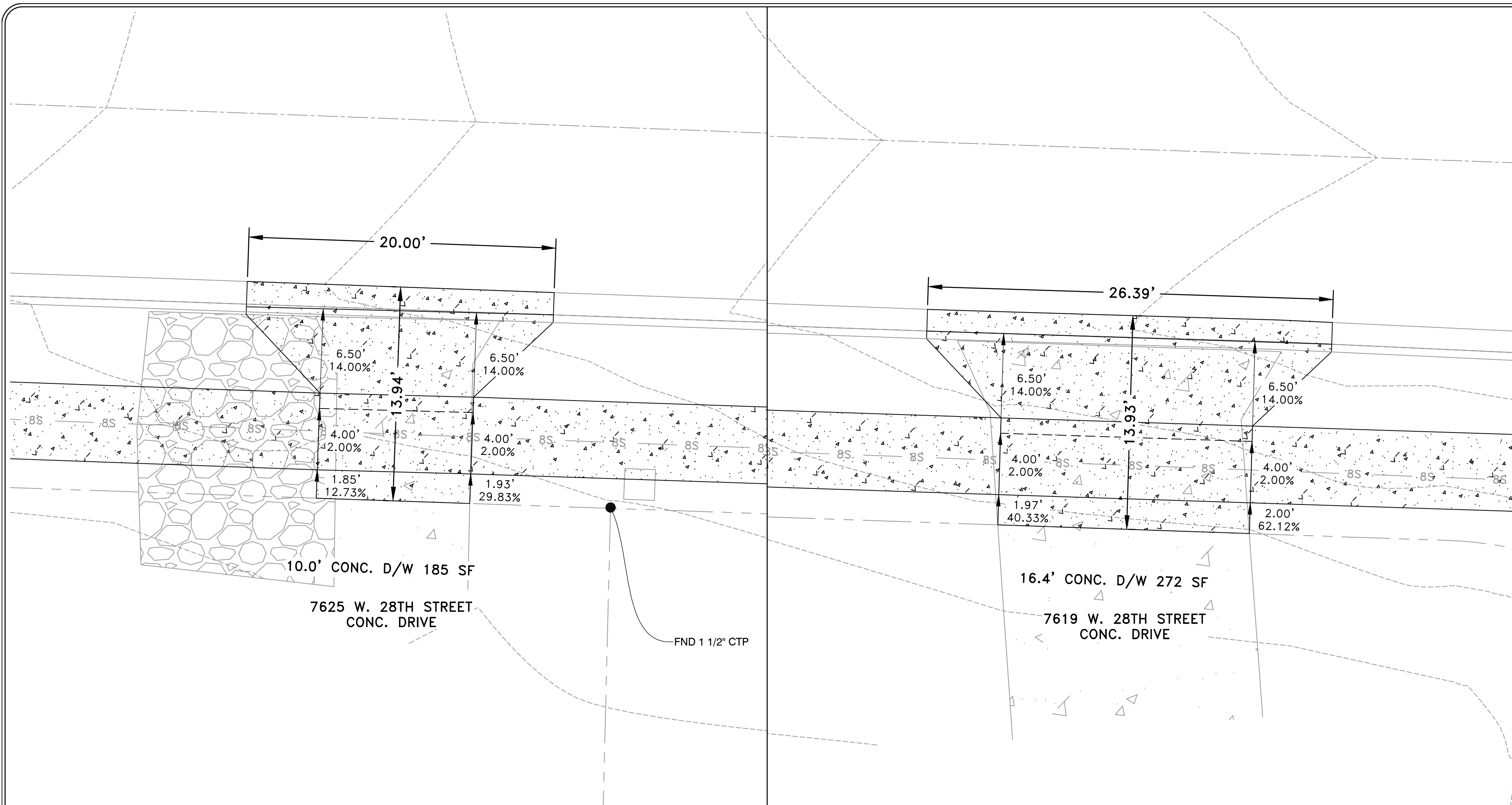

REVISIONS	DATE

WARD 6 SIDEWALKS
CITY OF LITTLE ROCK, ARKANSAS
DRIVEWAY PROFILES 3 - 28TH ST

DEPARTMENT OF PUBLIC WORKS
 CIVIL ENGINEERING
 701 W. MARKHAM
 LITTLE ROCK, ARKANSAS 72201



DRAWN BY
 KMH
DESIGNED
 KMH
CHECKED
 FJS
DATE
 10-28-2024
SCALE
 1"=20'
PROJECT NO.
 06-xx-SW-XX
SHEET NO.
C14